















## ARMSTRONG METALWORKS™ BOX PLANK

- Linear profile ceiling to mask the plenum and provide 100% accessibility to lighting, ventilation and sprinklers with an homogeneous appearance.
- Creates a modern, discontinuous visual for a space
- Variety of design options available – fully customizable
- 100% accessible to plenum (HVAC, lighting)
- Helps mask the plenum
- Fast and easy installation with minimal plenum clearance

# ARMSTRONG METALWORKS™ BOX PLANK

Panel Options	Box Plank: Multiple Profile Linear Ceiling	
 <b>Edge details</b>	 <p>Linear Profile: Square Edge      Baffle Profile: Square Edge</p>	
 <b>Material</b>	Aluminium	
 <b>Patterns</b>	 <p>Non Perforated (M1)</p>	
 <b>Dimensions (mm)</b>	Linear Profile: 100 x 3000 / 175 x 3000 / 250 x 3000 Baffle Profile: 25 (W) x 30 / 50 / 75 / 100 / 150 (H) x 3000 (L)	
 <b>Suspension System</b>	Rack Bar Carrier (Standard Void at 50mm between panels. Void distance configurable by request)	
 <b>Weight</b>	≈3.5 kg/m <sup>2</sup> (Linear profile)	
 <b>Colour</b>	Polyester Powder Coated – Global White  Wood Effects Available by Request	
 <b>Fire reaction</b>	CLASS 0/1 based on BS 476 Part 6 & 7	
 <b>Handling</b>	Downward Accessibility with tooling. Inherent void between panels allow limited plenum access.	
<b>Cleanability</b>		

Suspension and Accessories	
Item Number	Description
AC-RB-50	Rack Bar Carrier
PB025H_ _ _ CO*	Baffle Profile Connector
PB025H_ _ _ ECWH*	Baffle Profile End Cap (WH)

\* \_ \_ \_ = Height in mm (e.g. 30mm = 030, 100mm = 100).  
 Item number may vary due to configurable nature of spacing.  
 Perimeter Option: Compatible standard range of steel or aluminum trim.  
 All sizes are nominal. Product availability may vary.

## Typical Schematic

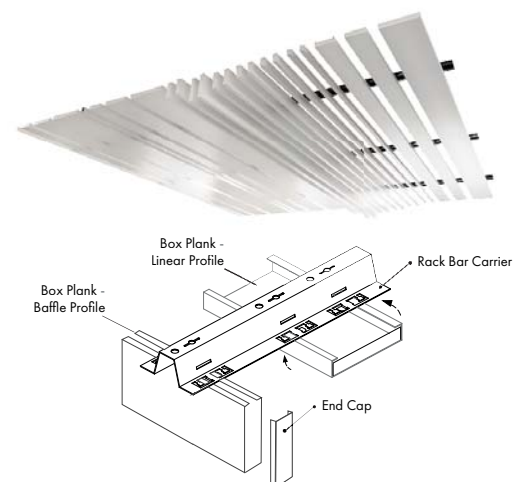

## Contact

For further details, please contact your local representative or email [asia.support@knaufarmstrong.com](mailto:asia.support@knaufarmstrong.com)