

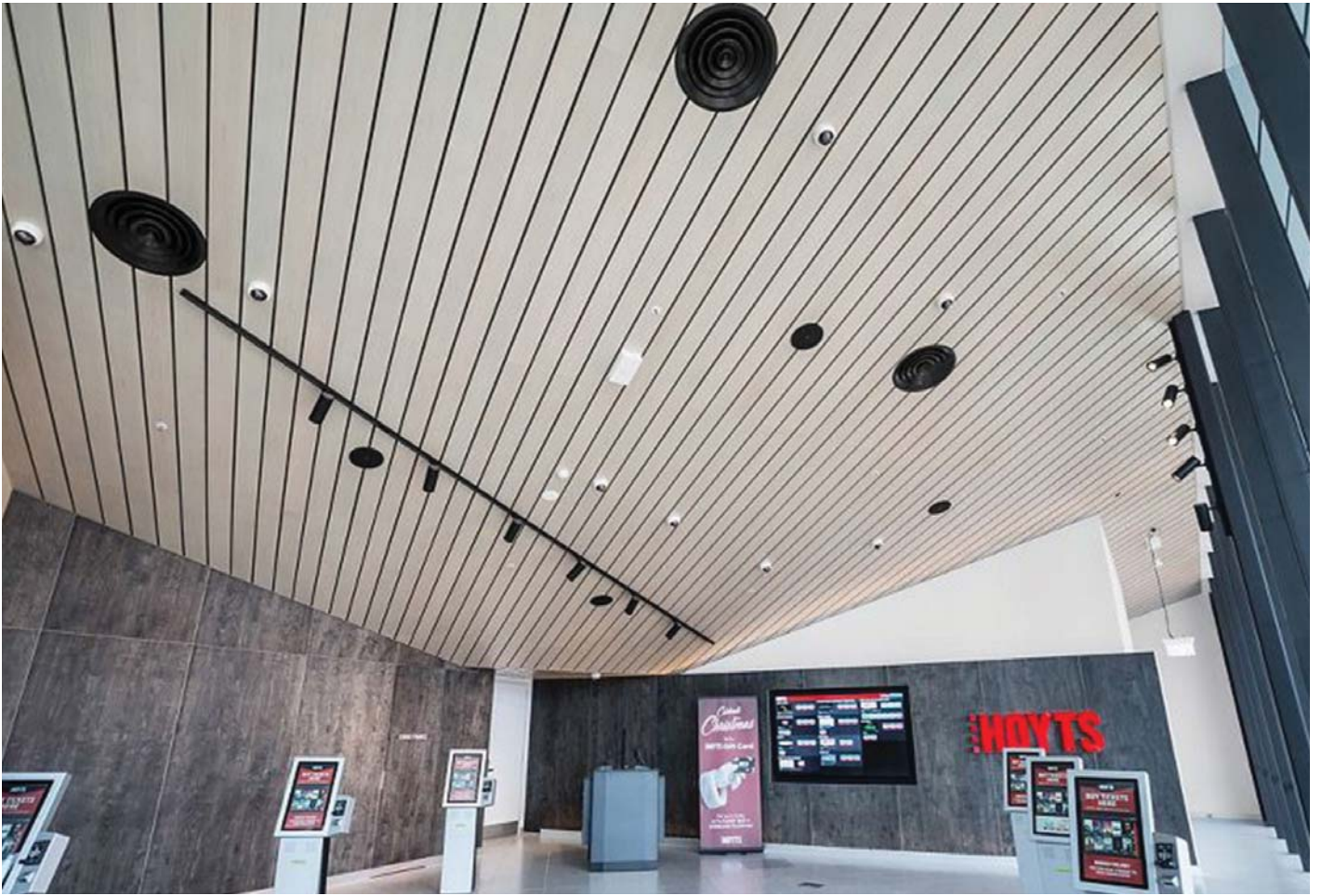

## ARMSTRONG METALWORKS™ F-PLANK

- Flexibility is the key with METALWORKS F-Plank, which combine a range of profile and colour options with the a sophisticated linear visual
- Acoustical options with microperforated panels
- Three Profile widths: 100, 200 and 300mm (nom) including a 20mm reveal
- Fast and easy installation
- Durable – Washable, Scrubbable, Impact-resistant, Soil-resistant Typical Applications

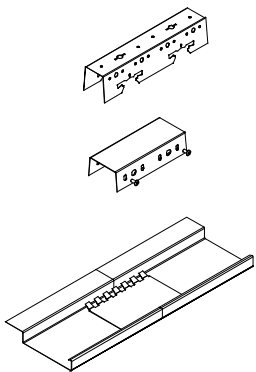

### Suspension Accessories

	Item Number	Description	Dimensions (mm)
	BP5497M	Carrier Rail	40 x 40 x 3000
	BP5499M	Carrier Rail Joiner	38 x 16 x 100
	BP5495M	100mm Panel Splice Plate	100
	BP5496M	200mm Panel Splice Plate	200
	BP5575M	300mm Panel Splice Plate	300

### Perimeter Trim

		Panel end cap available on request (for Floating Ceiling Application)	
	AC-WM-2023	Aluminium Wall Angle	20 x 23 x 3000
	AC-WM-203020	C-Wall Molding	20 x 30 x 20 x 3000
	AC-PC-203020	C-Wall Molding Pressure Spring	-

For wider range of perimeter trim option, please contact your local sales representative.





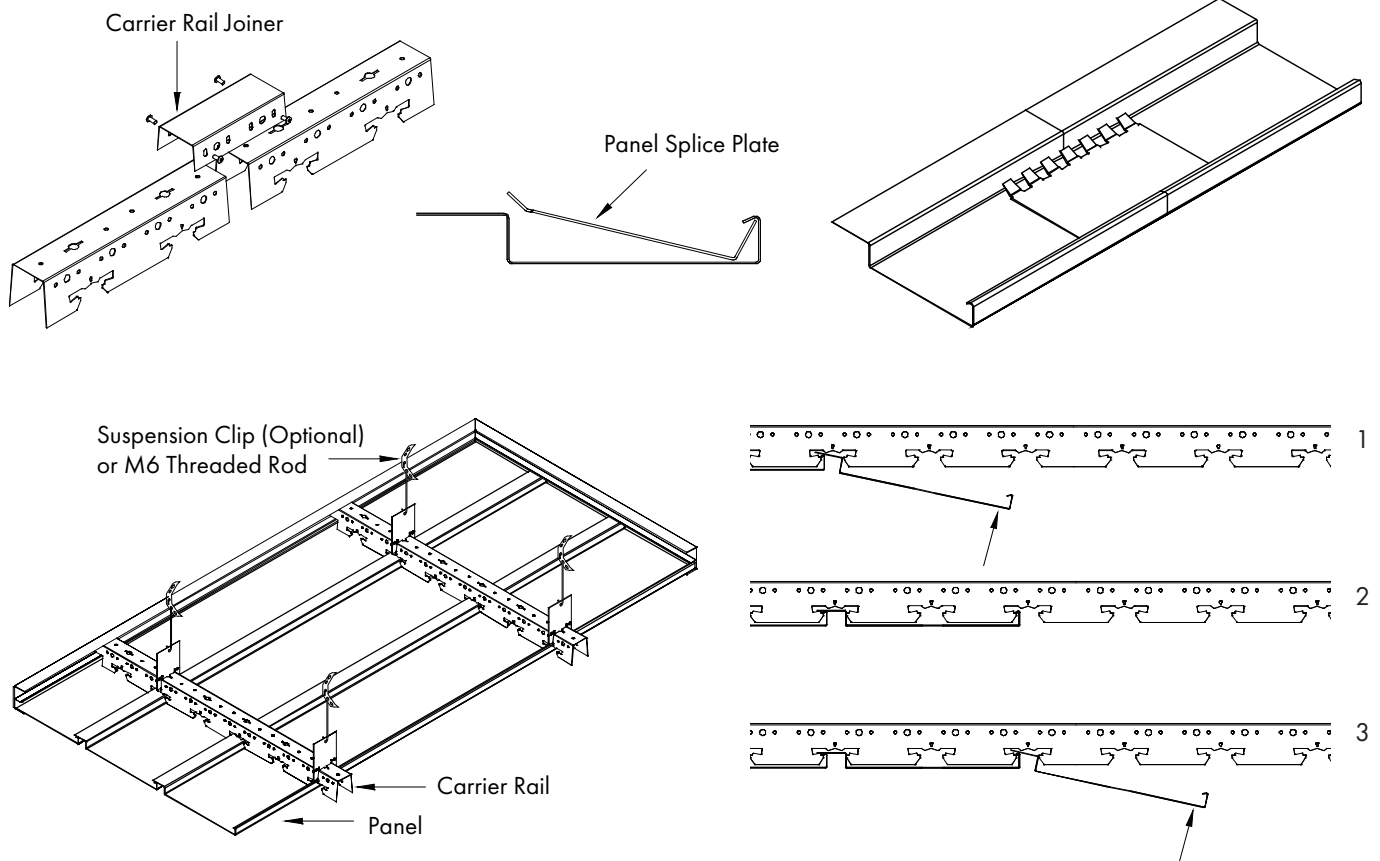



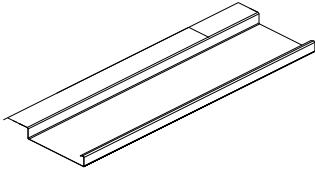
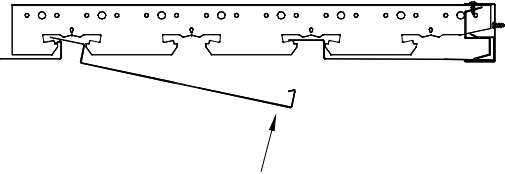

## Installation Detail

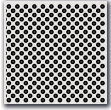

METALWORKS F-Plank are simply raised into position and clicked into the Carrier Rail.

Refer to the METALWORKS F-Plank System Components and also the Assembly and Installation Instructions for more details.

Panel Options	F-Plank: Liner Strip Ceiling System with Reveal – Interior Application	
<b>Edge details</b>	  <p>Square with Extended Flange / Aquiline hook-end</p>	
<b>Material</b>	Galvanized Steel 0.7mm	
<b>Patterns</b>	  <p>Plain Non Perforated (M1)      Micro Perforated (M2).  <small>* Micro perforated panels feature an unperforated border and include acoustical fleece.</small></p>	
<b>Dimensions (mm)</b>	<p>F100 : 100 (W) x 2400 / 3000 (L)                      F200 : 200 (W) x 2400 / 3000 (L)                      F300 : 300 (W) x 2400 / 3000 (L)</p>	
<b>Weight</b>	8.07 kg/m <sup>2</sup>	
<b>Colour</b>	Polyester Powder Coated – Global White  Wood Effects Available by Request	
<b>Sound absorption</b>	Up to NRC 0.70 (Perforated Option with fleece, without additional infill)	
<b>Sound attenuation</b>	Approximately 18 dB	
<b>Fire reaction</b>	CLASS 0/1 based on BS 476 Part 6 & 7	
<b>Accessibility</b>	Limited Accessibility, Access hatch may be required. F-Plank is non-demountable, suitable to be applied for secured ceiling application	
<b>Durability</b>		
<b>Cleanability</b>	  	
<b>Sustainability</b>	 Knauf Armstrong provides the widest range of products that have been third party tested and certified by industry leading Eco-classification 25%	

All sizes are nominal. Product availability may vary.

## Contact

For further details, please contact your local representative or email [asia.support@knaufarmstrong.com](mailto:asia.support@knaufarmstrong.com)